

Napoli
Art.Nr. 2821301
1/6



28.04.2014

Art.Nr. 2821301

GROUNDPLAN - GRUNDPLAN - PLAN DE MASSE - PLANIMETRIA

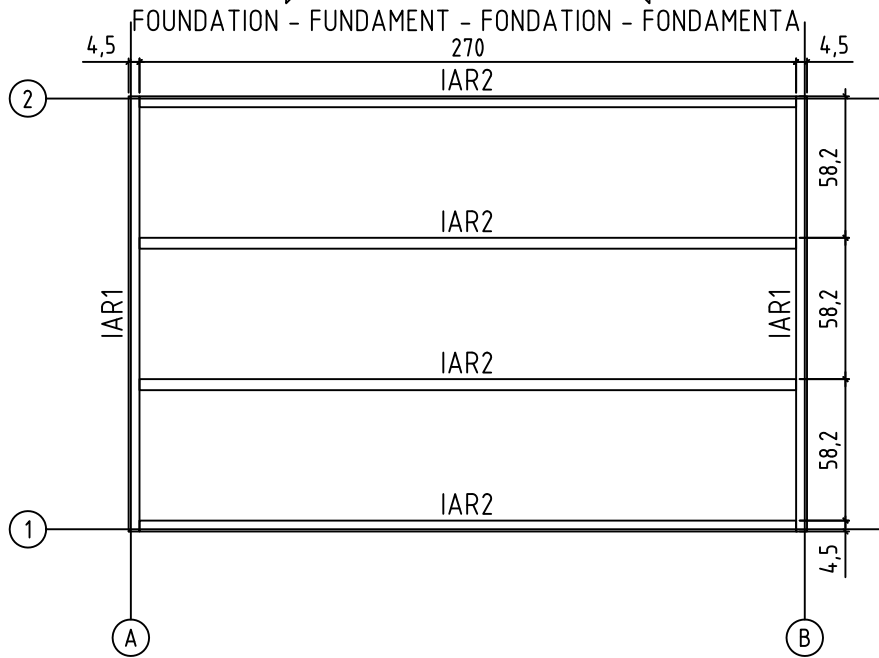
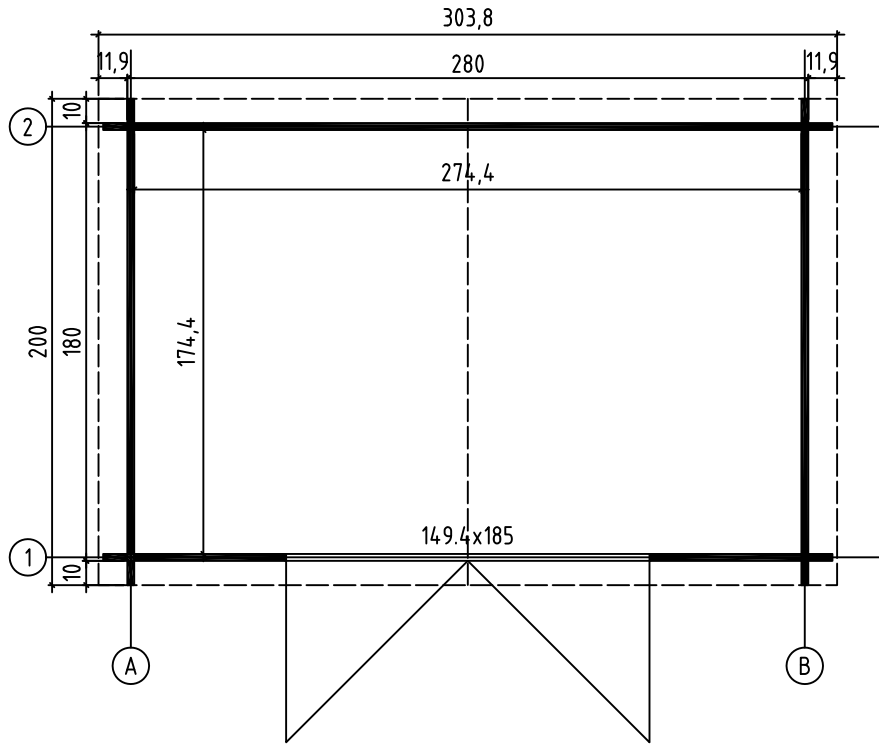

FLOOR BOARDS - FUSSBODENBRETTER - PLAN POSE PLANCHER -
POSIZIONAMENTO DELLE PERLINE DEL PAVIMENTO SULLE ASSI DELLE FONDAMENTA

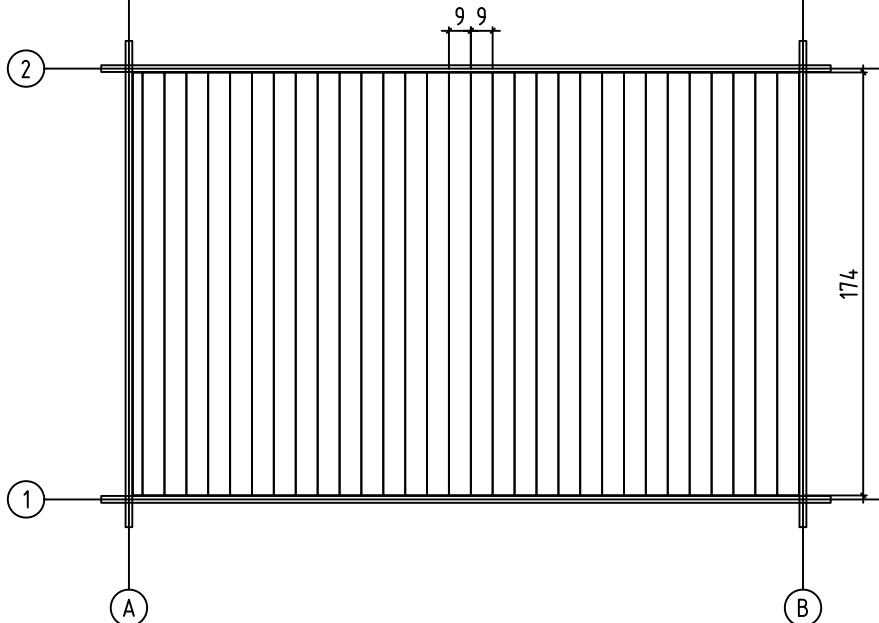

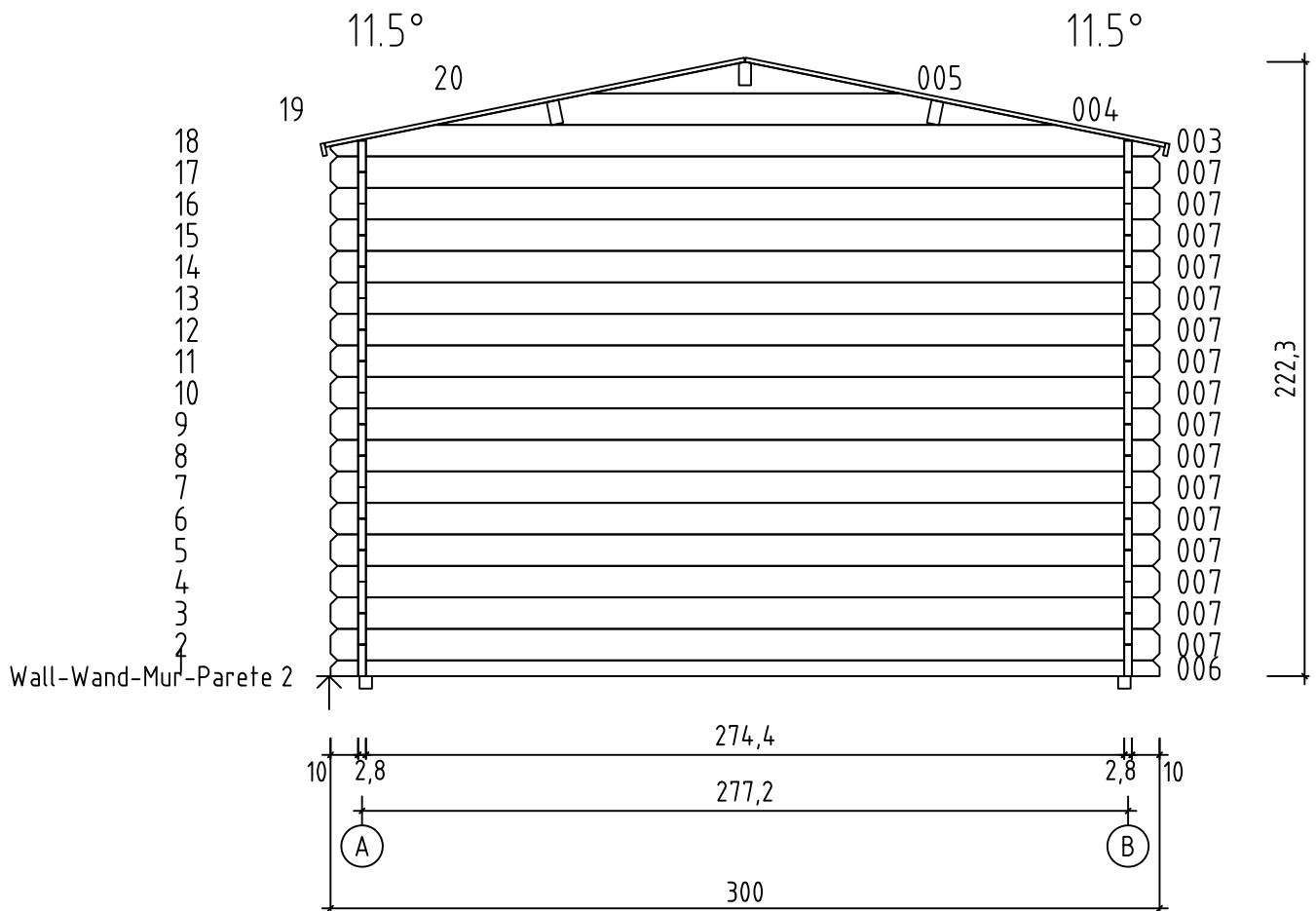
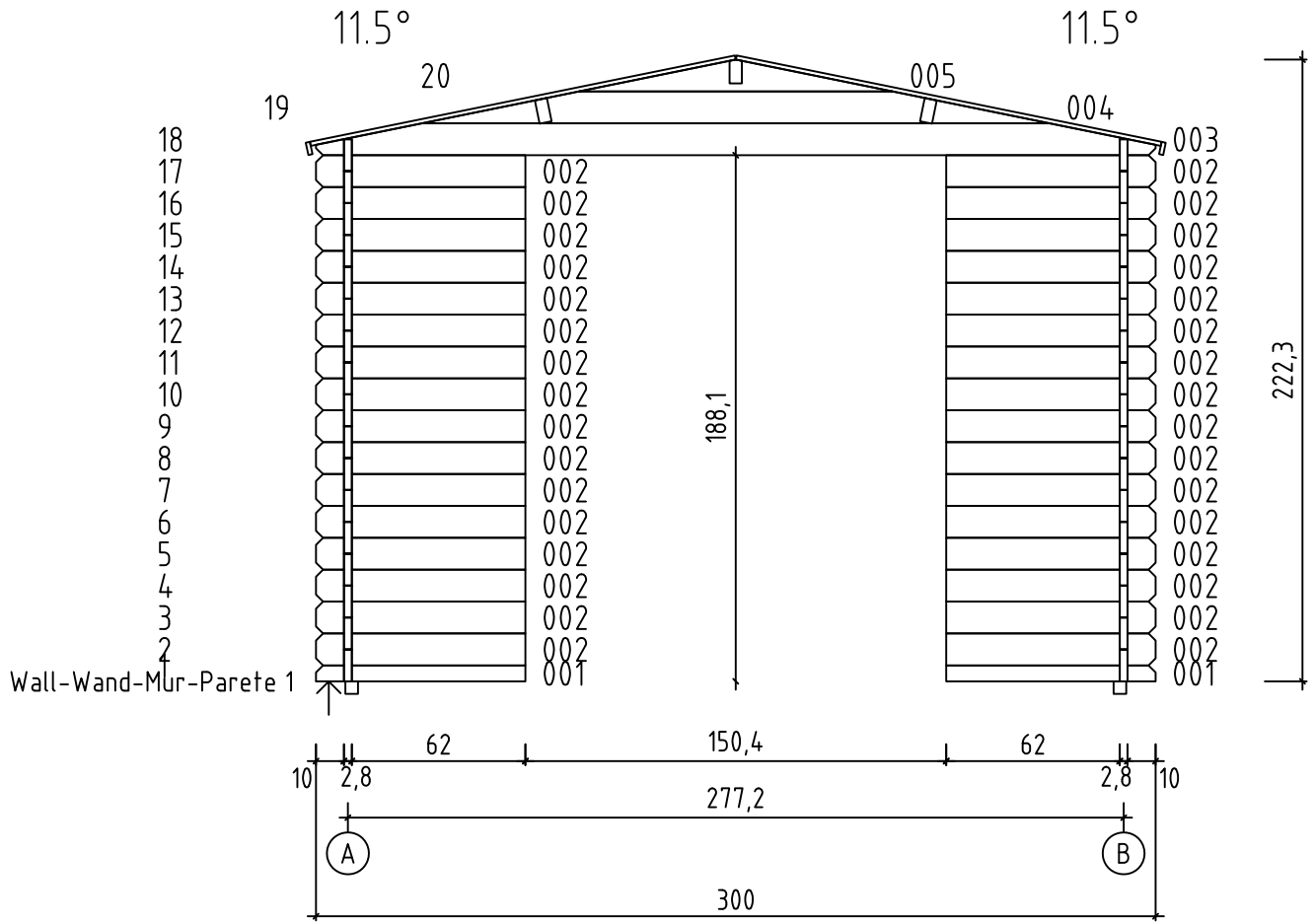



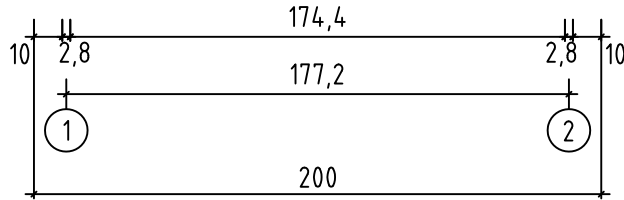
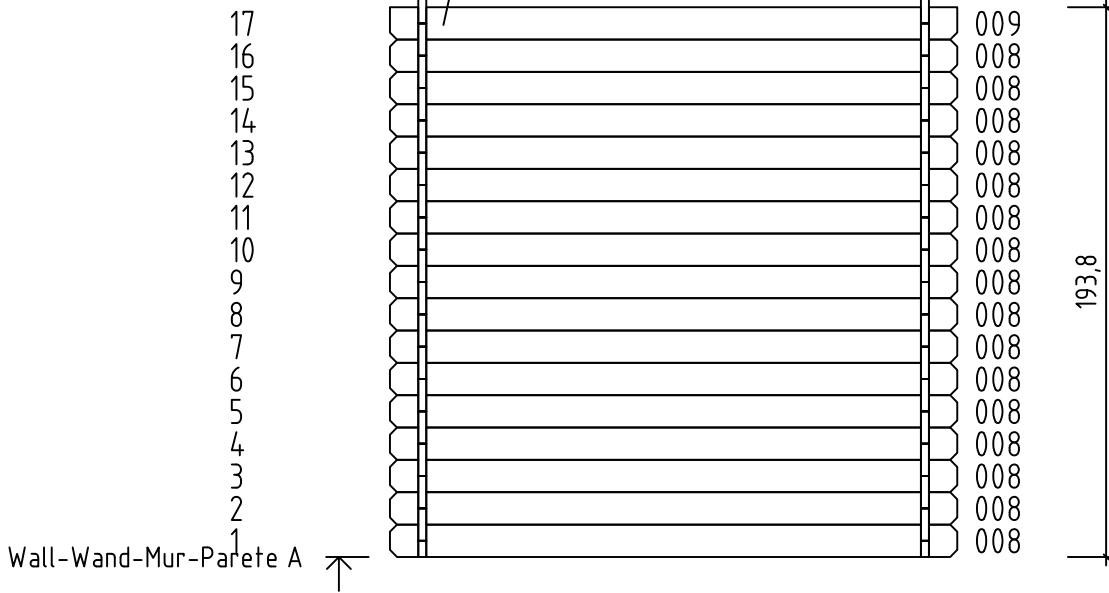



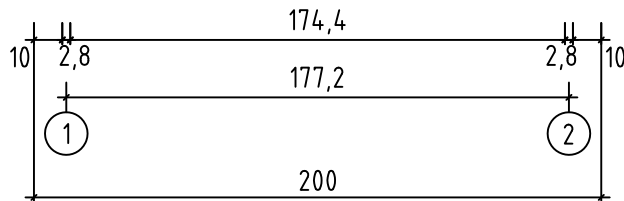
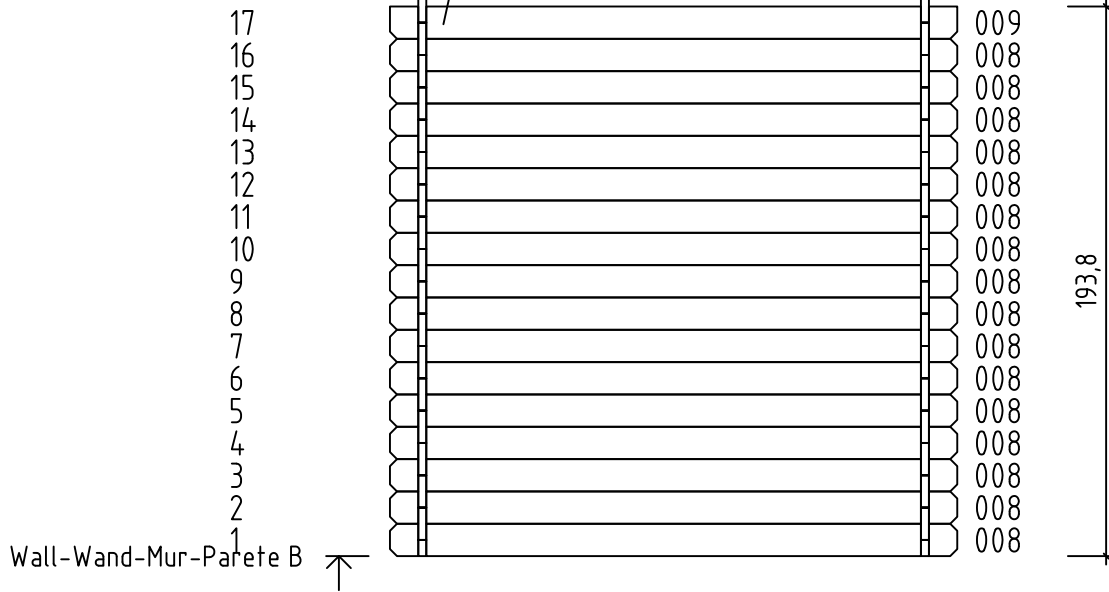



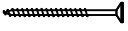
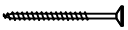
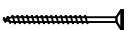

WITHOUT TONGUE - OHNE FEDER - MADRIER DE FINITION-TIMPANO



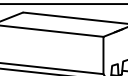

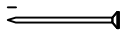
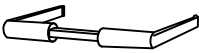

WITHOUT TONGUE - OHNE FEDER - MADRIER DE FINITION-TIMPANO

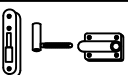
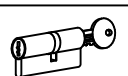
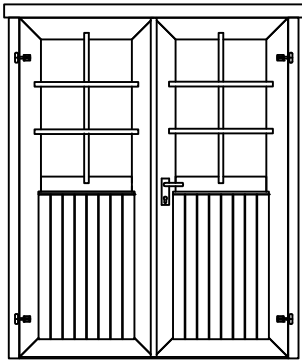

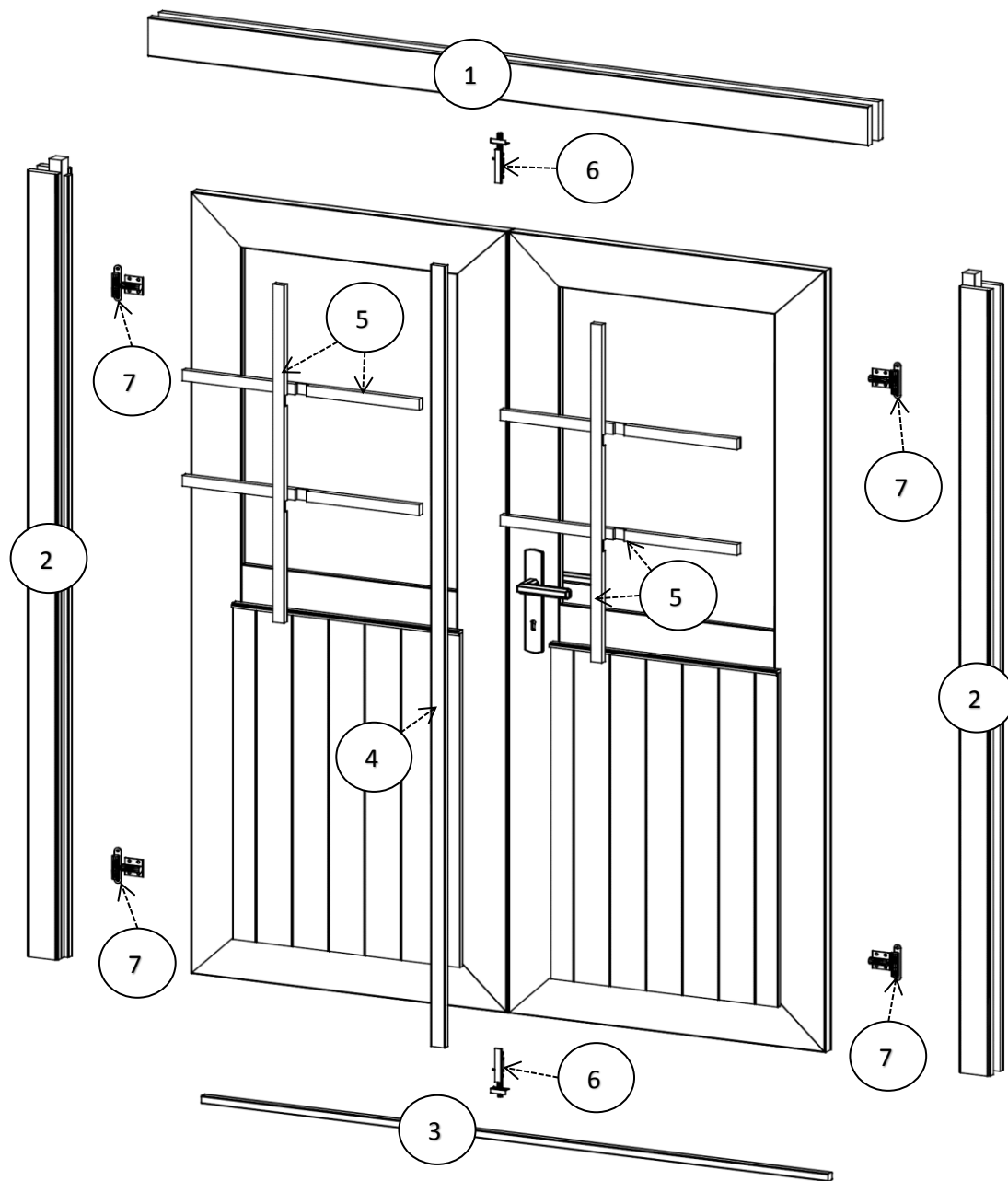
Pos	28.04.2014	Piece list - Stückliste - Liste des pièces - Elementi Art.Nr. 2821301	5/6	Q	P (mm)	L (mm)
001				2	28x57	748
002				32	28x114	748
006				1	28x57	3000
007				16	28x114	3000
008				32	28x114	2000
009				2	28x114	2000
W1-1				1		
W2-1				1		
IAR2	FOUNDATION - FUNDAMENT - FONDATION - ASSI IMPREGNATE PER FONDAMENTA			4	45x45	2700
IAR1	FOUNDATION - FUNDAMENT - FONDATION - ASSI IMPREGNATE PER FONDAMENTA			2	45x45	1790
PR11	ROOF BEAM - DACHBALKEN - PANNE DE TOIT - ASSE PORTANTE DEL TETTO			1	44x120	2000
A.PR21	ROOF BEAM - DACHBALKEN - PANNE DE TOIT - ASSE PORTANTE DEL TETTO			2	44x120	2000
	FLOOR BOARDS - FUSSBODENBRETTER - LAME DE PLANCHER - - PERLINE PER PAVIMENTO			31	90x15	1740
	ROOF BOARDS - DACHBRETTER - VOLIGES - PERLINA PER TETTO			46	90x15	1550
FL	FLOOR FILLET-FUSSBODENLEISTE - CORNIERE DE FINITION DU PLANCHER - PICCOLO BATTISCOPIA PER PAVIMENTO				18x18	8.96
DPL	ROOFING FELT FILLET - DACHPAPPENLEISTE - BAGUETTE DE FIXATION DU FEUTRE BITUMEUX - ASSE PER FISSAGGIO GUAINA BITUMINOSA			4	15x45	1600
DPP	ROOFING FELT - DACHPAPPE - FEUTRE BITUMEUX - CARTONE CATRAMATO			4		2100
TB	EAVES BOARD - TRAUFBRETT - BANDEAU DE TOIT - GRONDA - LATERALE PER TETTO			2	15x45	2000
GL	GABLE MOULDING - GIEBELLEISTE - PLANCHE DE RIVE - FINITURA PER FRONTALE E RETRO DEL TETTO			4	15x90	1600
HS89	SCREW FOR GEORGIAN BARS - SCHRAUBE FÜR SPROSSEN - VIS DE BARRES GEORGIENNE - VITE PER PROFILO PL			12	2.5x20	
HS12	SCREW FOR GABLE SEGMENT - SCHRAUBEN FÜR DECKBLATT - - VIS POUR FIXATION LOSANGE DE FINITION - VITI PER ROMBO DI FINITURA GS			4	3.5x35	
HS22	SCREW FOR FIXING DOOR TO THE WALL - SCHRAUBE ZUR BEFESTIGUNG TÜR - ZARGE MIT WAND - VIS DE FIXATION DORMANT DE PORTE			2	3.5x50	
HS16	SCREW FOR GABLE MOULDING - SCHRAUBEN FÜR GIEBELLEISTE - VIS DE FIXATION POUR PLANCHE DE RIVE - VITE PER FISSARE FINITURE D'AVANTI E DIETRO DEL TETTO			24	3.5x50	
HS3	SCREW FOR DOOR FILLET - SCHRAUBE ZUR BEFESTIGUNG TÜRLEISTE - VIS D'ASSEMBLAGE DU CADRE DE PORTE - VITI ASSEMBLAGGIO TELAIO PORTA			5	3x30	
HS59	SCREW FOR DOORSTEP - SCHRAUBEN FÜR SWELLE - VIS DE FIXATION DU SEUIL DE PORTE - VITI DI FISSAGGIO DAVANZALE DELLA PORTA			3	3x30	

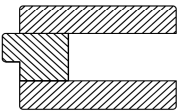
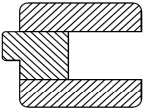
Pos	28.04.2014	Piece list - Stückliste - Liste des pièces - Elementi Art.Nr. 2821301	6/6	Q	P (mm)	L (mm)
		SCREW FOR FIXING BOLT HINGE - SCHRAUBE FÜR TÜRRIEDEL - VIS DE FIXATION POUR CHARNIERES ET GONDS DE PORTE - - VITI PER FISSAGGIO CARDINI E CERNIERE DELLA PORTA		16	4x30	
HS32		SCREW FOR EAVES BOARDS - SCHRAUBEN FÜR TRAUFBRETTEN - VIS DE FIXATION POUR BANDEAU DE TOIT - VITI PER FISSAGGIO ASSI PER GRONDE LATERALI DEL TETTO		10	4x40	
		SCREW FOR FIXING BOLT HINGE - SCHRAUBE FÜR TÜRRIEDEL - VIS DE FIXATION POUR CHARNIERES ET GONDS DE PORTE - - VITI PER FISSAGGIO CARDINI E CERNIERE DELLA PORTA		12	4x40	
HS77		SCREW FOR DOOR JAMB - SCHRAUBE FÜR TÜRRAHMEN - VIS DE FIXATION POUR MONTANT DE PORTE - VITI PER FISSAGGIO DCGLI STIPITI DELLA PORTA		2	4x60	
HS43		SCREW FOR ROOF BEAMS - SCHRAUBEN FÜR DACHBALKEN - VIS POUR PANNE DE TOIT - VITI PER PERLINE DEL TETTO		10	5x120	
HS40		SCREW FOR 1. WALL BEAM - SCHRAUBE FÜR 1. BOHLENREIHE - VIS DE FIXATION DES FONDATIONS - VITI DI FISSAGGIO DEL PRIMO GIRO DI PERLINE DELLE PARETI SULLE ASSI DELLE FONDAMENTA		7	5x90	
HS39		SCREW FOR FUNDAMENT - SCHRAUBEN ZUR BEFESTIGUNG FUNDAMENT - VIS POUR FONDATION - VITI PER FONDAMENTA		8	5x90	
HS41		SCREW FOR DOOR JAMB - SCHRAUBE FÜR TÜRRAHMEN - VIS DE FIXATION POUR MONTANT DE PORTE - VITI PER FISSAGGIO DCGLI STIPITI DELLA PORTA		2	5x90	
NFF		ZN NAIL FOR FLOOR FILLET - ZN NÄGEL FÜR FUSSBODENLEISTE - - POINTE POUR CORNIERE DE FINITION DU PLANCHER - - CHIODI PER FISSARE BATTISCOPA DI FINITURA DEL PAVIMENTO		19	1.4x40	
SH28		HAMMER BLOCK - SCHLAGHOLZ - CALLE DE FRAPPE - - BLOCCO DI LEGNO PER MARTELLARE		1		
NFD		ZN NAIL FOR ROOFING FELT FILLET - ZN NÄGEL FÜR DACHPAPPENLEISTE - - POINTE POUR BAGUETTE FIXATION FEUTRE BITUMEUX - CHIODI PER FISSARE LE ASSI DI FISSAGGIO DELLA GUAINA BITUMINOSA		16	2x40	
NF		ROOFING NAILS FOR ROOFING FELT - NÄGEL FÜR DACHPAPPE - POINTE DE FIXATION POUR FEUTRE BITUMEUX - CHIODI PER CARTONE CATRAMATO		75	2.1x17	
TL		LATCH BOLT FOR DOUBLE DOOR - TORRIEGEL - LOQUET POUR DOUBLE PORTE - SCROCCO PER PORTA DOPPIA		2		
GS		GABLE SEGMENT - DECKBLATT - LOSANGE DE FINITION - ROMBO DI FINITURA		2		
NF2		ZN NAIL FOR ROOF - ZN NÄGEL FÜR DACHBRETTEN - POINTE POUR TOIT - - CHIODI PER FISSARE LE PERLINE DEL TETTO		152	2x50	
NH1		ZN NAIL FOR FLOOR - ZN NÄGEL FÜR FUSSBODENBRETTEN - CLOUS POUR PLANCHER - CHIODI PER FISSARE LE PERLINE DEL PAVIMENTO		128	2x50	
TS3		DOOR HANDLE FITTINGS - TÜRGRIFF - SET DE GARNITURES DE SERRURE DE PORTE - SET SERRATURA DI PORTA		1		
TS4		DOOR LOCK COVER - SCHLOSSBLLENDE - GARNITURE DE SERRURE DE PORTE - - COPERCHI DELLA SERRATURA DELLA PORTA		1		
TT		MALE BOLT HINGE FOR DOOR - TÜRRIEDEL - PARTIE MALE DE CHARNIERE DE PORTE - BULLONE MASCHIO PER CERNIERA DI PORTA		4		
TS6		CYLINDER LOCK - ZYLINDERSCHLOSS - CYLINDRE DE SERRURE - - CILINDRO DI SERRATURA		1		
		DOOR - TÜR - PORTE 1494x1850 TUK.2. 056.SVP.MX28	SGA	1		
						

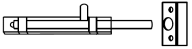
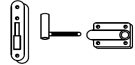

Pos	Piece list - Stückliste - Liste des pièces	Q.	P (mm)
1		1	66x100
2		2	66x80
3		1	18x18
4		1	13x32
5		6	15x25
6		2	
7		4	

